

GW5xxC15Lx2

Light Emitting Diode Module



■ Part Numbering

Letters	Emission Color	Part Number
BW	Normal White	GW5BWC15L02
BD	Tungsten	GW5BDC15L02
BN	High Color Rendering (5,000 K)	GW5BNC15L02
BN	High Color Rendering (6,500 K)	GW5BNC15L12

■ Features

1. High output (GW5BWC15L02: 280 lm at $I_F = 360$ mA)
2. 36 LEDs in series-parallel array
3. White (from InGaN Blue LED chip + Phosphor)

■ Agency Approvals/Compliance

1. RoHS compliant

■ Applications

1. Illumination

Notice The content of data sheet is subject to change without prior notice.
In the absence of confirmation by device specification sheets, SHARP takes no responsibility for any defects that may occur in equipment using any SHARP devices shown in catalogs, data books, etc. Contact SHARP in order to obtain the latest device specification sheets before using any SHARP device.

Outline Dimensions and Terminal Connections

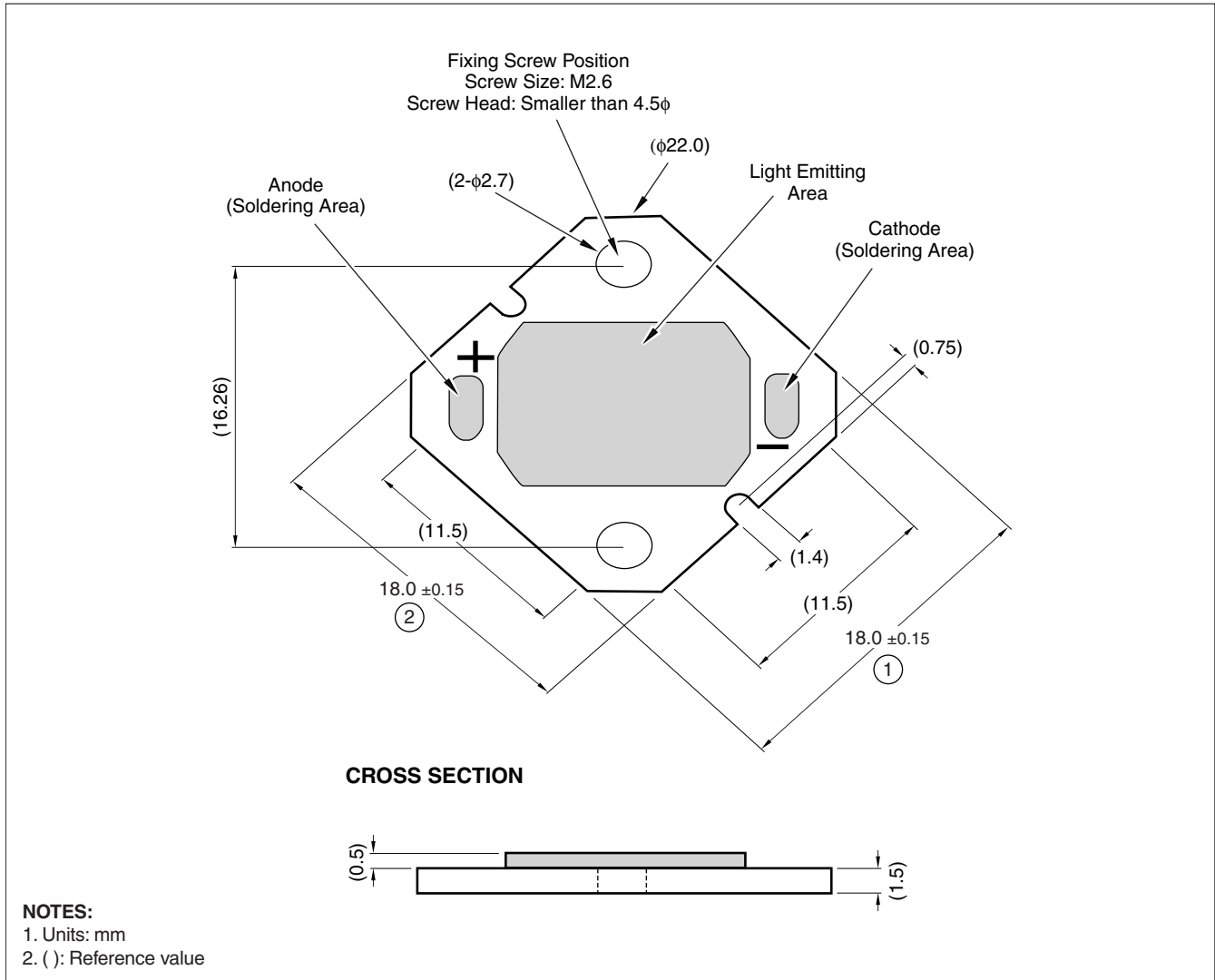

Internal Circuit Diagram

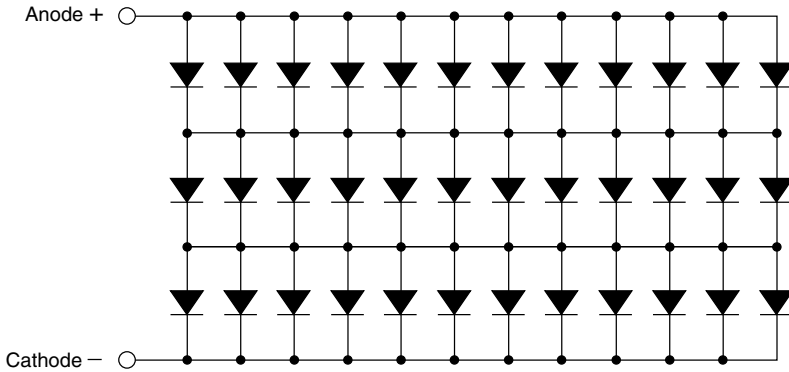

Absolute Maximum Ratings

(Ta = 25°C)

Parameter	Symbol	Rating	Unit
Power dissipation *1	P	4.4	W
Forward current *1	IF	400	mA
Reverse voltage	VR	-5	V
Operating temperature *2	Topr	-30 to +90	°C
Storage temperature	Tstg	-40 to +100	°C

*1 This value of Power Dissipation assumes the use of an adequate heat sink to keep the module below its maximum operating temperature at the rated current.
 *2 Operating Temperature is fixed by the module's external temperature, and is measured at the point shown in Figure 7. Follow the derating curve given in Figure 1.

Electro-optical Characteristics

(Ta = 25°C)

Parameter		Symbol	Conditions	MIN.	TYP.	MAX.	Unit
Forward Voltage		VF	IF = 360 mA	8.5	(10.2)	11.5	V
Luminous Flux *1	BW: Normal White	φ	IF = 360 mA	220	(280)	–	lm
	BD: Tungsten	φ	IF = 360 mA	150	(190)	–	lm
	BN: High Color Rendering	φ	IF = 360 mA	135	(170)	–	lm
Chromaticity *2	BW: Normal white	x	IF = 360 mA	–	0.35	–	
		y		–	0.35	–	
		Tc		(4,700)	5,000	(5,300)	K
	BD: Tungsten	x	IF = 360 mA	–	0.45	–	
		y		–	0.41	–	
		Tc		(2,550)	2,800	(3,050)	K
	BN: High Color Rendering (5,000 K)	x	IF = 360 mA	–	0.35	–	
		y		–	0.35	–	
		Tc		(4,700)	5,000	(5,300)	K
	BN: High Color Rendering (6,500 K)	x	IF = 360 mA	–	0.31	–	
		y		–	0.32	–	
		Tc		(6,000)	6,500	(7,000)	K

*1 Measured with the use of an integrating sphere. Accuracy ±20%
 *2 Measured with Ohtsuka Electronics Model MCPD-2000. Accuracy: x, y ±0.02

Fig. 1 Derating Curve

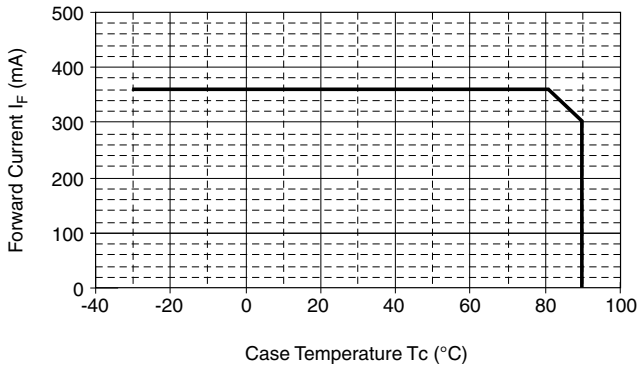

NOTE: To keep this part within its rating, enough heatsinking capability must be employed. Sharp recommends using 360 mA for an average value when calculating heatsink capacity.

Fig. 2 Forward Voltage vs. Case Temperature

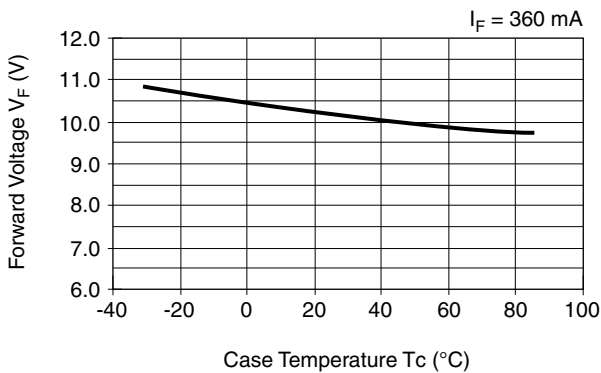

Fig. 3 Forward Current vs. Forward Voltage

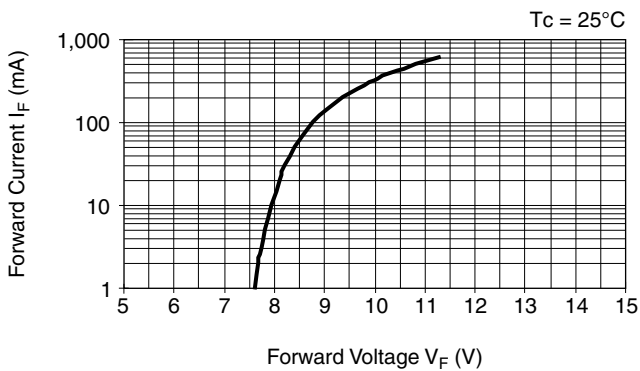

Fig. 4 Relative Luminous Intensity vs. Case Temperature

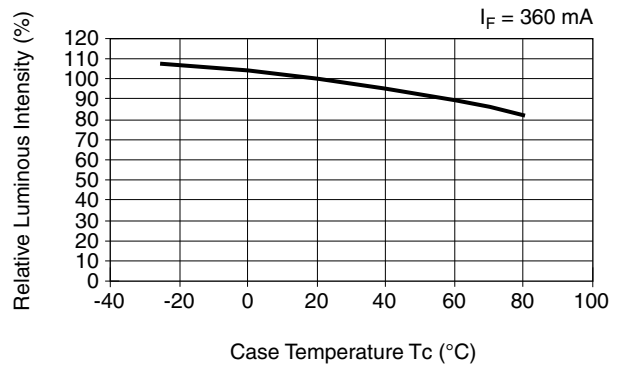

Fig. 5 Relative Luminous Intensity vs. Forward Current

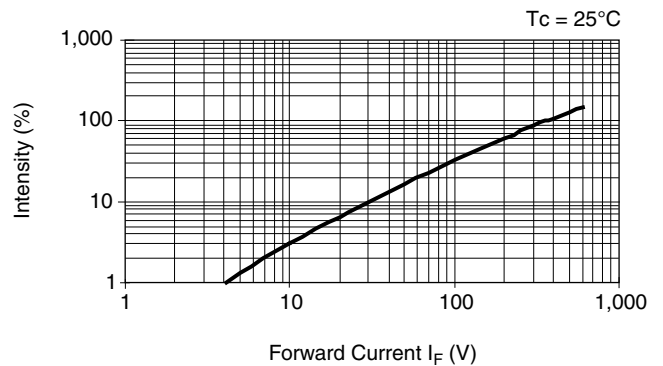

Fig. 6 Chromaticity Coordinate vs. Case Temperature

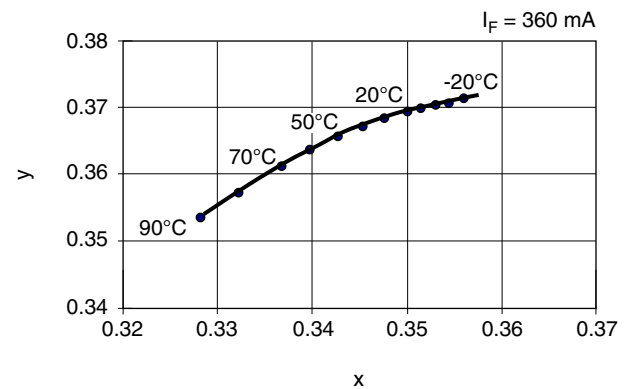

Fig. 7 Case Temperature Measurement Point

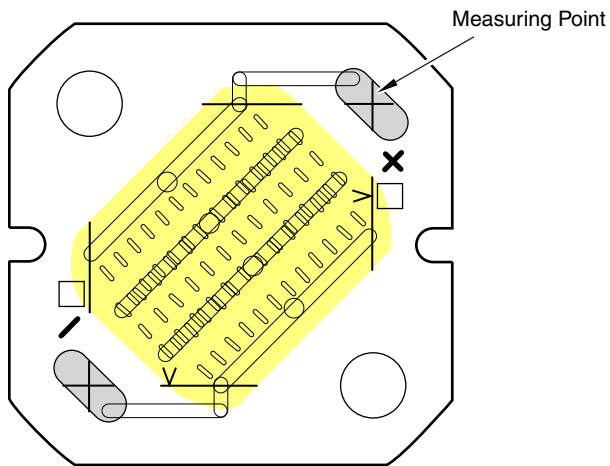
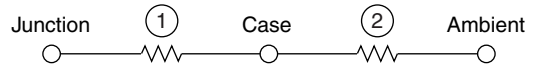

Fig. 8 Thermal Resistance



NOTES:

- ① Thermal resistance: 6.5°C/W (Reference value) (Junction to Case)
- ② Thermal resistance: Depends on the performance of any attached heat sink. (Case to Ambient)

Fig. 9 Heatsink Attachment

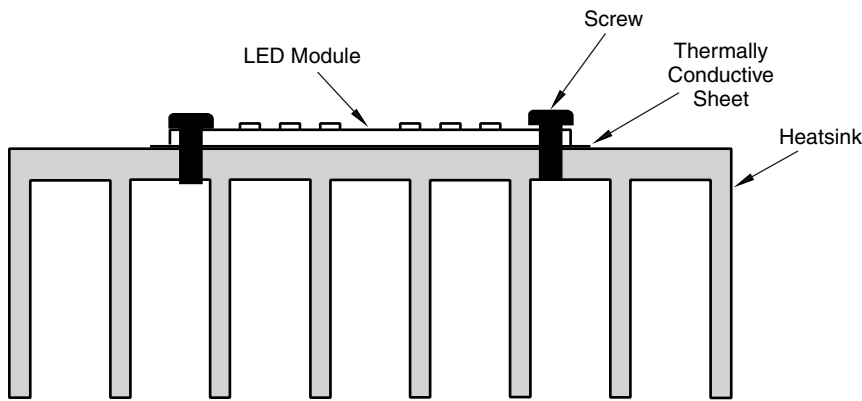

■ Chromaticity Coordinates

($I_F = 360 \text{ mA}$) ($T_a = 25^\circ\text{C}$)

GW5BWC15L02 Chromaticity

Normal white	x	0.3380	0.3367	0.3541	0.3592
	y	0.3640	0.332	0.3586	0.3946

GW5BDC15L02 Chromaticity

Tungsten	x	0.4467	0.4212	0.4565	0.4901
	y	0.4310	0.3770	0.3861	0.4424

GW5BNC15L02 Chromaticity

High Color Rendering (5,000 K)	x	0.3380	0.3365	0.3513	0.3571
	y	0.3640	0.3275	0.3390	0.3797

GW5BNC15L12 Chromaticity

High Color Rendering (6,500 K)	x	0.3024	0.3101	0.3235	0.3206
	y	0.3361	0.2984	0.3110	0.3544

Measurement Accuracy: ± 0.02

Fig. 10 Chromaticity Coordinates

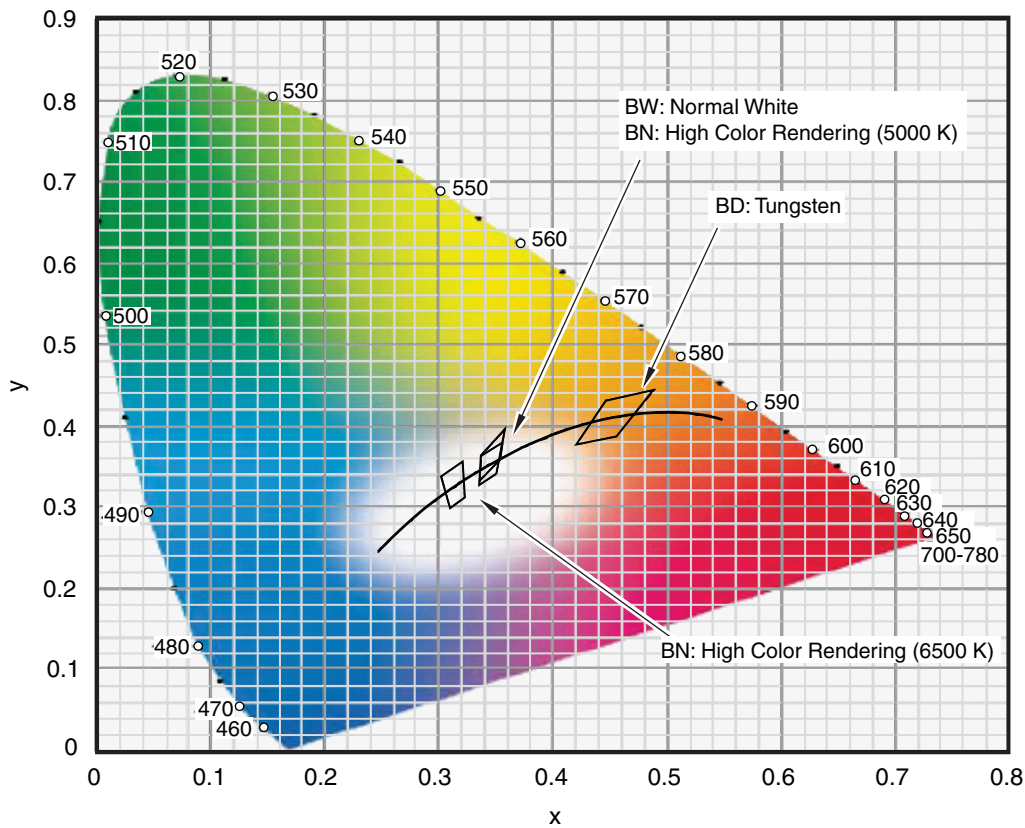

■ Design Considerations**Design Guidelines**

1. This product is not designed to be electromagnetic- and ionized-particle-radiation resistant.
2. Always use an adequate heatsink with this part, in combination with either (or both) a thermally conductive sheet or heat-conducting grease.
3. Do not allow the circuit design to apply any reverse voltage to the LEDs.
4. This module requires a constant-current source for its drive. A constant-voltage supply may provide more than the rated current due to lowered V_F created caused by part heating.
5. If current in excess of the rated maximum are supplied to this part, hazardous conditions may be created, including excess heating, smoke emission, or a possible fire. Take appropriate measures to control excess current and voltage.
6. If the lead wire to the part comes loose, it could contact the case or heatsink, thereby creating a short circuit and possible shock hazard. Take appropriate measures to prevent the lead wire from coming into contact with other parts.

■ Manufacturing Guidelines**Cleaning Instructions**

1. Sharp does not recommend cleaning this part, as the silicone resin may be corroded by solvents.

Soldering Instructions

1. Sharp recommends soldering by hand, with a thermally-controlled iron at 380°C; within 10 seconds for each place. Solder on a surface that does not conduct heat.
2. When soldering, do not touch the tip of the iron to the yellow phosphor.
3. This product is not designed for solder reflow or solder flow methods.
4. Do not subject the package to excessive mechanical force during soldering as it may cause deformation or defects in plated connections. Internal connections may be severed due to mechanical force placed on the package due to the PCB flexing during the soldering process.

Mechanical Installation Instructions

1. Sharp recommends taking particular notice of the installation method, as the mounting board's material is aluminumized ceramic. If incorrectly installed, problems with non-radiation may occur due to cracking of the mounting board.
2. Use screws, adhesives, or both when mounting this device to its heatsink. When using only adhesives, be sure to check their effectiveness. Use thread locking materials to prevent screws from loosening due to thermal cycling. If the part is separated from its heatsink, a catastrophic temperature rise may occur, causing self-desoldering, device deterioration if not destruction, and smoke emission.
3. When screw mounting:
 - Refer to Fig. 11 for the recommended dimensions.
 - Screw torque: within 0.2 N•m.
 - Use thread locking materials.
 - Use materials with low galvanic action, such as stainless steel.
 - Do not use flathead screws, which can cause substrate cracks due to stress at the screw holes.
 - Do not install the part into a board which is warped in a convex direction. This part can be easily damaged by torquing it to a convexly-warped mounting surface.
 - To maximize thermal efficiency between the device and its heatsink, Sharp recommends a thermally-conductive sheet and conductive grease.
 - Circuit board cracks can be caused when screws are tightened; be sure to check the actual conditions carefully.

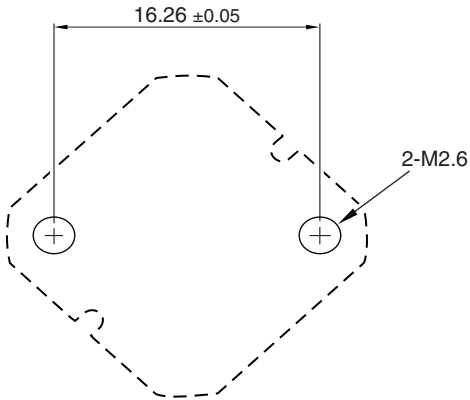
Fig. 11 Screw-mounting Dimensions**Storage and Handling**

1. Store these parts between 5° and 30°C, at a relative humidity of less than 60%.
2. After breaking the package seal, maintain the environment within 5° to 30°C, at a relative humidity of less than 60%, and mount the parts within one week.
3. This part is not designed to directly resist excessive moisture, such as dew or condensation; or corrosive (salt) air or corrosive gases, such as Cl, H₂S, NH₃, SO₂, NO_x.
4. This part can be easily damaged by external stress. Make sure it is not mechanically stressed during or after assembly.
5. This part has a very high light output. Looking directly at it during full power output can cause injury.
6. Sharp recommends taking proper personal and environmental static control precautions when handling this part.
7. Sharp recommends handling these parts in a clean, non-dusty environment since surface dust may be difficult to remove and can affect the optical performance of the part.
8. Sharp recommends confirming the part's performance, reliability, and resistance to any of these conditions, if it is to be used in any of these environments:
 - Direct sunlight, outdoor exposure, dusty conditions
 - In water, oil, medical fluids, and organic solvents
 - Excessive moisture, such as dew or condensation
 - Corrosive (salt) air or corrosive gases, such as Cl, H₂S, NH₃, SO₂, NO_x

■ Packing Specifications

1. Tray shape and dimensions conforms to those shown in Fig. 12.
2. Number of parts per box: 500
3. Number of parts per tray: 35, packed as:
 - 14 trays or 10, when shipping just one tray.

Packaging Method

1. Trays are packed in moisture-proof bags in groups of 15 then sealed.
2. This set is placed in an outer shipping box.
3. Shipping box dimensions: 235 × 220 × 90 mm.

■ Packing Specifications

Fig. 12 Tray Shape and Dimensions

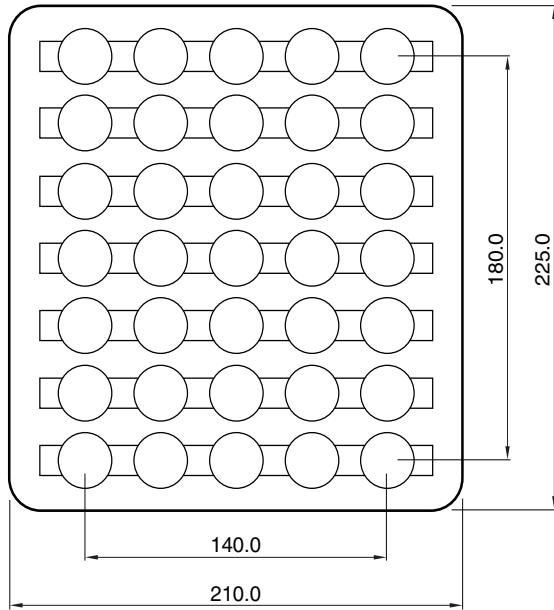

NOTE: Units: mm

Fig. 13 Label Information

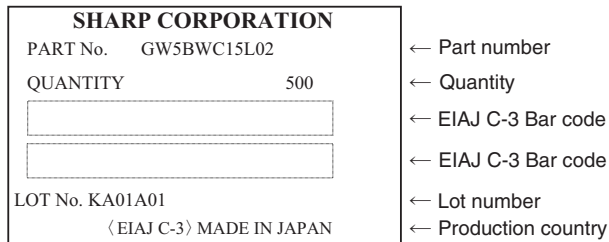

Lot Number

KA 01 A 01

① ② ③ ④

- ① Production plant code (alphabetically)
- ② Production year (the last two digits of the year)
- ③ Production month
(to be indicated alphabetically with January corresponding to A)
- ④ Production date (01 ~ 31)

■ Presence of ODCs (RoHS Compliance)

This product shall not contain the following materials, and they are not used in the production process for this product:

- Regulated substances: CFCs, Halon, Carbon tetrachloride, 1.1.1-Trichloroethane (Methylchloroform). Specific brominated flame retardants such as the PBBOs and PBBs are not used in this product at all.

This product shall not contain the following materials banned in the RoHS Directive (2002/95/EC).

- Lead, Mercury, Cadmium, Hexavalent chromium, Polybrominated biphenyls (PBB), Polybrominated diphenyl ethers (PBDE).

■ Important Notices

· The circuit application examples in this publication are provided to explain representative applications of SHARP devices and are not intended to guarantee any circuit design or license any intellectual property rights. SHARP takes no responsibility for any problems related to any intellectual property right of a third party resulting from the use of SHARP's devices.

· Contact SHARP in order to obtain the latest device specification sheets before using any SHARP device. SHARP reserves the right to make changes in the specifications, characteristics, data materials, structure, and other contents described herein at any time without notice in order to improve design or reliability. Manufacturing locations are also subject to change without notice.

· Observe the following points when using any devices in this publication. SHARP takes no responsibility for damage caused by improper use of the devices which does not meet the conditions and absolute maximum ratings to be used specified in the relevant specification sheet nor meet the following conditions:

(i) The devices in this publication are designed for use in general electronic equipment designs such as:

- Personal computers
- Office automation equipment
- Telecommunication equipment (terminal)
- Test and measurement equipment
- Industrial control
- Audio visual equipment
- Consumer electronics

(ii) Measures such as fail-safe function and redundant design should be taken to ensure reliability and safety when SHARP devices are used for or in connection with equipment that requires higher reliability such as:

- Transportation control and safety equipment (i.e., aircraft, trains, automobiles, etc.)
- Traffic signals
- Gas leakage sensor breakers
- Alarm equipment
- Various safety devices, etc.

(iii) SHARP devices shall not be used for or in connection with equipment that requires an extremely high level of reliability and safety such as:

- Space applications
- Telecommunication equipment (trunk lines)
- Nuclear power control equipment
- Medical and other life support equipment (e.g. scuba)

· If the SHARP devices listed in this publication fall within the scope of strategic products described in the Foreign Exchange and Foreign Trade Law of Japan, it is necessary to obtain approval to export such SHARP devices.

· This publication is the proprietary product of SHARP and is copyrighted, with all rights reserved. Under the copyright laws, no part of this publication may be reproduced or transmitted in any form or by any means, electronic or mechanical, for any purpose, in whole or in part, without the express written permission of SHARP. Express written permission is also required before any use of this publication may be made by a third party.

· Contact and consult with a SHARP representative if there are any questions about the contents of this publication.